

# 225 WATTS

## NXT-225 SERIES AC-DC

### FEATURES:

- RoHS Compliant
- 2 Year Warranty
- High Efficiency, 85% typical
- High Power Density, 10.0 W / cu in.
- Compact 3.0" x 5.0" x 1.5" size
- EN 60950-1 ITE Certification
- EN 60601-1 Medical Certification
- EMC to EN 61000-6-2 & EN 60601-1-2
- Advanced SMT Design
- Optional Chassis/Cover
- Optional Single Wire Load Sharing
- Optional Remote Inhibit/Enable

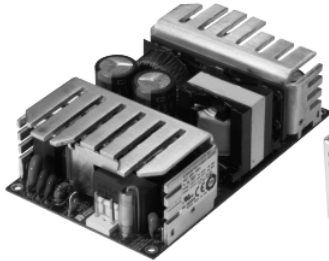





OPEN FRAME



CHASSIS/COVER

### SAFETY SPECIFICATIONS

General	Protection Class: I	
	Overvoltage Category: II	
	Pollution Degree: 2	
	Underwriters Laboratories File E137708/E140259	UL 60950-1 2 <sup>nd</sup> Edition, 2007 UL 60601-1 1 <sup>st</sup> Edition, 2006 AAMI/ANSI ES 60601-1, 2005
		CB Reports/Certificates (including all National and Group Deviations) IEC 60950-1/A1:2009, Second Edition IEC 60601-1:1988 +A1:1991 +A2:1995 IEC 60601-1:2005 Third Edition
	UL Recognition Mark for Canada File E137708/E140259	CAN/CSA-C22.2 No. 60950-1-07, 2 <sup>nd</sup> Edition CAN/CSA-C22.2 No. 601-1-M90, 2005 CAN/CSA-C22.2 No. 60601-1:2008
	TUV	EN 60950-1/A12:2011 EN 60601-1/A2:1995 EN 60601-1:2006
	Low Voltage Directive RoHS Directive (Recast)	(2006/95/EC of December 2006) (2011/65/EU of June 2011)

### MODEL LISTING

MODEL	OPEN FRAME		CHASSIS/COVER	
	300 LFM	CONVECTION COOLED	300 LFM	CONVECTION COOLED
NXT-225-1001	2.5V/53.0A	2.5V/30.0A	2.5V/47.7A	2.5V/27.0A
NXT-225-1002	3.3V/53.0A	3.3V/30.0A	3.3V/47.7A	3.3V/27.0A
NXT-225-1003	5V/45.0A	5V/30.0A	5V/40.5A	5V/27.0A
NXT-225-1004	12V/18.8A	12V/12.5A	12V/16.9A	12V/11.3A
NXT-225-1005	15V/15.0A	15V/10.0A	15V/13.5A	15V/9.0A
NXT-225-1006	24V/9.4A	24V/6.3A	24V/8.5A	24V/5.7A
NXT-225-1007	28V/8.0A	28V/5.4A	28V/7.2A	28V/4.9A
NXT-225-1008	48V/4.7A	48V/3.1A	48V/4.2A	48V/2.8A

Please refer to Output Power Derating chart.

### ORDERING INFORMATION

Please specify the following optional features when ordering:

- CH - Chassis  
CO - Cover  
LS - Single Wire Load Sharing
- LSEVB - Load Share Evaluation Board  
RE - Remote Inhibit

All specifications are maximum at 25°C, 225W unless otherwise stated, may vary by model and are subject to change without notice.

### OUTPUT SPECIFICATIONS

Output Power at 50°C	150W	Convection Cooled, Open Frame
	225W	300 LFM Forced Air, Open Frame
Power Derating	1.5 W <sub>out</sub> / 1 V <sub>in</sub> below 100 V <sub>in</sub>	
Voltage Centering	± 0.5%	(50% load)
Voltage Adjust Range	95-105%	
Load Regulation	0.5%	(0-100% load change)
Source Regulation	0.5%	
Noise	1.0% or 100mV Whichever is greater	
Turn on Overshoot	None	
Transient Response	Output recovers to within 1% of initial set point due to a 50% step load change, 500µs maximum, 4% maximum deviation.	
Overvoltage Protection	Latching, between 110% and 150% of rated output voltage.	
Overpower Protection	110-130% rated P <sub>out</sub> , cycle on/off, auto recovery	
Hold Up Time	16 mS min., Full Power, 85-264V Input	
Start Up Time	3 Seconds, 120V Input	

### INPUT SPECIFICATIONS

Source Voltage	85 – 264 Volts AC	
Frequency Range	47 – 63 Hz	
Input Protection	Internal 5A Time Delay fuse	
Peak Inrush Current	50A (cold)	
Efficiency	85% Typical, Full Power varies by model	
Power Factor	0.95 (Full Power, 230V), 0.98 (Full Power, 120V)	

### ENVIRONMENTAL SPECIFICATIONS

Ambient Operating	0° C to + 70° C	
Temperature Range	Derating: See Power Rating Chart	
Ambient Storage Temp. Range	- 40° C to + 85° C	
Operating Relative Humidity Range	20-90% non-condensing	
Altitude	10,000 ft. ASL Operating/ 40,000 ft. ALS Non-Operating	
Temperature Coefficient	0.02%/°C	
Vibration	2.5g, 10Hz -2KHz per MIL-STD-810F Method 516.5	
Shock	20g, peak per MIL-STD-810F Method 516.5	

### GENERAL SPECIFICATIONS

Means of Protection	Primary to Secondary	2MOPP (Means of Patient Protection)
	Primary to Ground	1MOOP (Means of Operator Protection)
	Secondary to Ground	Operational Insulation(Consult factory for 1MOOP or 1MOPP)
Dielectric Strength <sup>(13)</sup>	Reinforced Insulation	5656 VDC, Primary to Secondary, 1 Sec.
	Basic Insulation	2545 VDC, Primary to Ground, 1 Sec.
	Operational Insulation	707 VDC, Secondary to Ground, 1 Sec.
Leakage Current	Earth Leakage	<300uA NC, <1000uA SFC
	Touch Current	<100uA NC, <500uA SFC
Power Fail Signal	Logic low with input power failure 10 ms minimum prior to output 1 dropping 1%.	
Remote Inhibit (optional)	Isolated. Contact closure inhibits output.	
Load Share (optional)	Single wire current sharing with return via negative sense return. Minimum current share load is 10% of each module's output current rating. Maximum output voltage deviation between modules is 5% for 2.5 through 5 V models and 400 mV for remaining models.	
Standby Power (optional)	Isolated 5 Vdc ± 10%, 10 mA available only with Remote Inhibit option.	
Remote Sense	400mV compensation of output cable losses	
Mean-Time Between Failures	100,000 Hours min., MIL-HDBK-217F, 25° C, GB	
Weight	0.98 Lbs. Open Frame/ 1.50 Lbs. Chassis and Cover	

### ELECTROMAGNETIC COMPATIBILITY SPECIFICATIONS

Electrostatic Discharge	EN 61000-4-2	± 6kV Contact/ ± 8kV Air Discharge
Radiated Electromagnetic Field	EN 61000-4-3	80-2500MHz, 10V/m, 80% AM
EFT/Bursts	EN 61000-4-4	± 2 kV
Surges	EN 61000-4-5	± 2 kV Line to Earth/ ± 1 kV Line to Line
Conducted Immunity	EN 61000-4-6	.15 to 80MHz, 10V, 80% AM
Magnetic Field Immunity	EN 61000-4-8	30A/m, 50/60 Hz.
Voltage Dips	EN 61000-4-11	95% Dip, 10ms 30% Dip, 500ms 60% Reduction, 1s (Criteria B)
Voltage Interruptions	EN 61000-4-11	95% Reduction, 5s
Radiated Emissions	EN 55011/22,	Class B
	FCC Part 15	
Conducted Emissions	EN 55011/22,	Class B
	FCC Part 15	
Harmonic Current Emissions	EN 61000-3-2	Compliance
Power Factor	EN 61000-3-2	Compliance
Voltage Fluctuations and Flicker	EN 61000-3-3	Compliance

# NXT-225 SERIES MECHANICAL SPECIFICATIONS

# APPLICATIONS INFORMATION

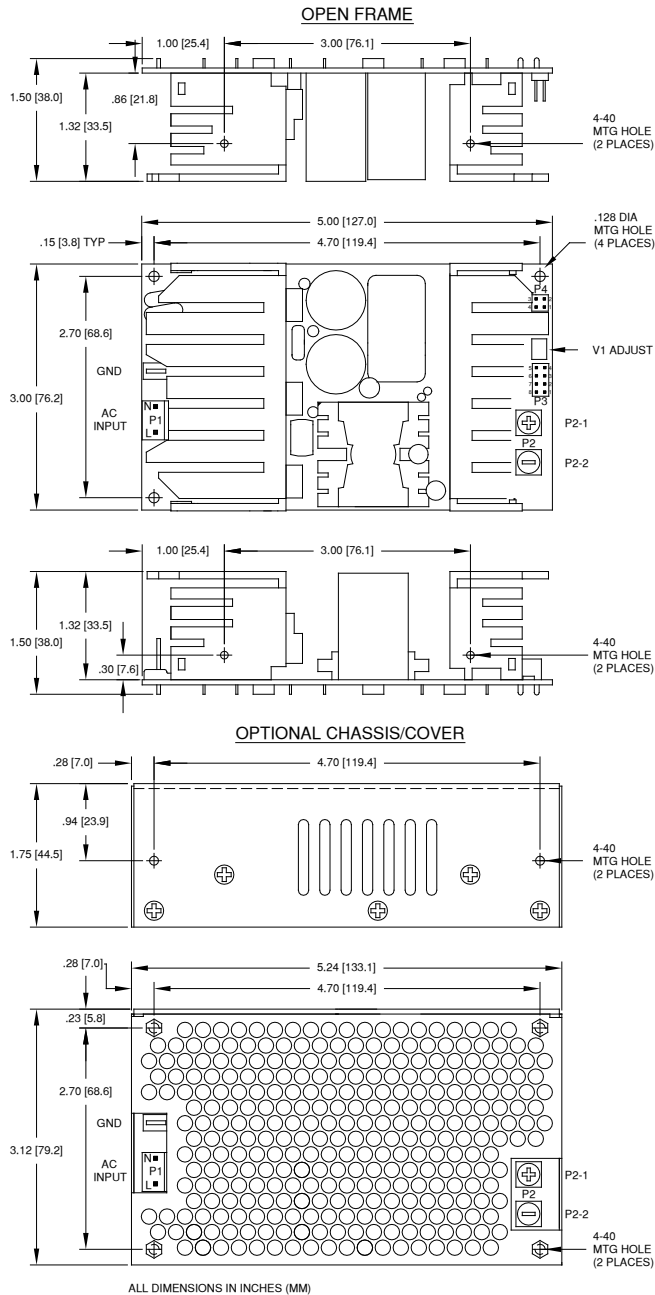

- Sufficient area must be provided around power supply to allow natural movement of air to develop in convection cooled applications.
- 300 linear feet per minute of airflow must be maintained one inch above the top of the heatsinks in any direction in open frame forced air applications.
- 300 linear feet per minute of airflow must be maintained one inch above and toward any of the three perforated sides of the cover in forced air chassis/cover applications.
- Generally, adequate cooling is provided when semiconductor case temperatures do not exceed 70° C rise and transformer temperature does not exceed 60° C rise at any specified ambient temperature.
- This product is intended for use as a professionally installed component within information technology, industrial and medical equipment and is not intended for stand alone operation. Common RF shielding precautions may need to be taken to assure emissions compliance. Refer to operating instructions for additional information.
- This product includes only one fuse in the input circuit. In consideration of Clause 8.11.5 of IEC 60601-1:2005, a second fuse may be required in the end product.
- Low forward voltage drop oring diodes must be used in all load sharing applications in 2.5 through 15 Volt models. Oring diodes must be used on 24 through 48 Volt models used in fault tolerant applications but are optional in power boosting applications. Oring diode power dissipation must be subtracted from the maximum output power rating of each model.
- Current carrying conductors in load sharing applications must be short and symmetrical. Remote sense conductors should be a twisted pair. The use of an appropriately rated low impedance capacitor across the load will increase noise immunity.
- Refer to Load Share Evaluation Board data sheet (page 58) for additional load share applications information.
- Remote sense terminals may be used to compensate for cable losses up to 400 mV depending on model. The use of a twisted pair, decoupling capacitors and an appropriately rated low impedance capacitor connected across the load will increase noise immunity.
- A load equal to 5% rated output power must be maintained when using standby power option. An external electrolytic capacitor across standby power output may be used to improve transient response.
- Peak to peak output ripple and noise is measured directly at the output terminals of the power supply, without the use of the probe ground lead or retractable tip, 20 MHz bandwidth.
- This product was type tested and safety certified using the dielectric strength test voltages listed in Table 6 of IEC 60601-1:2005. In consideration of Clause 8.8.3, care must be taken to insure that the voltage applied to a reinforced insulation does not overstress different types and levels of insulation. Primary and secondary to ground capacitors may need to be disconnected prior to performing a dielectric strength test on the power supply or the end product. It is highly recommended that the DC test voltages listed in DVB.1, Annex DVB of UL 60601-1 1<sup>st</sup> Edition are not exceeded during a production-line dielectric strength test of the assembled end product. Please consult factory for further information.
- This power supply has been safety approved and final tested using a DC dielectric strength test. Please consult factory before performing an AC dielectric strength test.
- Maximum screw penetration into bottom chassis mounting holes is .100 inches.
- Maximum screw penetration into side chassis mounting holes is .188 inches.
- To comply with emissions specifications, all four mounting hole pads must be electrically connected to a common metal chassis. Chassis/cover option recommended.

## MAX Pout vs. AMBIENT TEMPERATURE/INPUT VOLTAGE

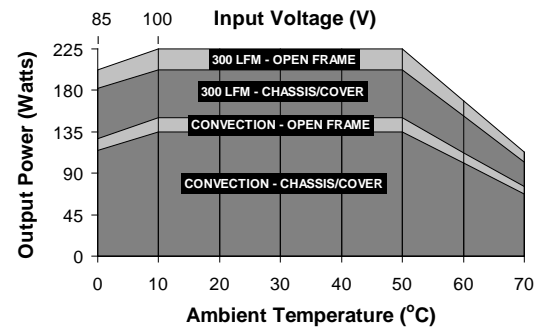

**Derating requirements** – Chart above applies to models 1003 thru 1008 only. 225 Watts 300 LFM forced air, open frame. 150 Watts convection cooled open frame. Derate 10% with chassis and cover. Derate 1.5  $V_{OUT} / V_{IN}$  below 100  $V_{IN}$  and between 100  $V_{IN}$  and 85  $V_{IN}$ . Use larger of the two deratings when using chassis/cover below 100  $V_{IN}$ . Derate output power linearly to 50% between 50° and 70° C

## CONNECTOR SPECIFICATIONS

<b>P1</b>	AC Input	.156 friction lock header mates with Molex 09-50-3031 or equivalent crimp terminal housing with Molex 2478 or equivalent crimp terminal.
<ul style="list-style-type: none"> <li>NEUTRAL</li> <li>LINE</li> </ul>		
<b>P2</b>	DC Output	6-32 screw down terminal mates with #6 ring tongue terminal. (10 in-lb Max)
OUTPUT 1 (-)	OUTPUT 1 (+)	
<b>P3</b>	Power Fail, Load Share, Sense	.100 friction lock header mates with Molex 22-55-2081 or equivalent crimp terminal housing with Molex 71851 or crimp equivalent terminal.
SHARE BUS 5	4 ENABLE	
P.F. SIG (+) 6	3 P.F. RTN	
SENSE (-) 7	2 OUTPUT 1 (-)	
SENSE (+) 8	1 OUTPUT 1 (+)	
<b>P4</b>	Inhibit, Standby Power	.100 friction lock header mates with Molex 22-55-2041 or equivalent crimp terminal housing with Molex 71851 or equivalent crimp terminal.
INHIBIT 3	2 INHIBIT RTN	
STBY PWR (+) 4	1 STBY RTN (-)	
Ground	Ground	.187 quick disconnect terminal.

## TYPICAL LOAD SHARE/REMOTE SENSE APPLICATION

